

OPERATING INSTRUCTIONS AND SAFETY NOTES

Hand lever grease gun

according to DIN 1283-H-500

Industrial grease gun ELITE K9

Industrial grease gun 1 and 2

Standard grease gun



Pressol Schmiergeräte GmbH

This documentation is exclusively intended for the operating company and their staff.

Without our written consent, the content of this documentation (textes, figures, drawings, charts, diagrams etc.), must not be duplicated or distributed, neither in full or in part, utilized for the purpose of competition or passed on/made available to third parties.

Pressol Schmiergeräte GmbH

Parkstraße 7

93167 Falkenstein | Germany

Phone +49 9462 17-0

Fax +49 9462 17-208

info@pressol.com

www.pressol.com

Operating instructions translation

Date of issue: 09/2019

We reserve the right to make design and product modifications, which serve to improve the product.

Table of Contents

| | | |
|-------|---|----|
| 1. | Introduction | 3 |
| 1.1 | Preface | 3 |
| 1.2 | Obligations of the personnel | 3 |
| 1.3 | Symbols in this manual | 3 |
| 1.3.1 | Structure of the warning notes | 3 |
| 1.3.2 | General symbols | 3 |
| 2. | Safety notes | 4 |
| 2.1 | Authorized personnel | 4 |
| 2.2 | Intended conditions of use | 4 |
| 3. | Design and functional description | 4 |
| 4. | Area of application | 4 |
| 5. | Technical data | 5 |
| 6. | Hazards when handling the grease gun | 5 |
| 7. | Assembly | 6 |
| 8. | First use and recommissioning | 6 |
| 8.1 | Filling the grease gun | 6 |
| 8.1.1 | Filling with grease gun filling device | 6 |
| 8.1.2 | Filling with grease cartridge according to DIN 1284 | 7 |
| 8.2 | Making the grease gun ready for operation | 8 |
| 9. | Operation | 8 |
| 10. | Care/Maintenance | 9 |
| 11. | Replacement parts/accessories | 9 |
| 12. | Disposal | 10 |
| 13. | Repair/Service | 10 |

1. Introduction

1.1 Preface

Please carefully read these operating instructions and observe in particular all safety notes!

Our staff will be pleased to provide support if you have any questions about the product.

Yours sincerely, Pressol Schmiergeräte GmbH

1.2 Obligations of the personnel

Before commencing work, all persons who are entrusted to work with the hand lever grease gun are obliged:

- to follow all applicable regulations on occupational safety and accident prevention.
- to read and to comply with all safety instructions and warning notes contained in these operating instructions.

Please observe the following instructions in the interest of all concerned:

- Refrain from any unsafe working methods!
- Adhere to all hazard and warning notes contained in this manual!
- In addition to this documentation, keep to all generally accepted safety rules, legal provisions as well as all other binding rules regarding occupational safety, accident prevention and environmental protection!
- Wear appropriate protective clothing in accordance with the work to be done!
- Perform only work for which you have been sufficiently trained and instructed!
- Only genuine spare parts as well as original tools and auxiliaries of the manufacturer are allowed to be used in order to ensure the functional safety and maintain the warranty coverage.

1.3 Symbols in this manual

1.3.1 Structure of the warning notes

The warning notes have the following structure:



SIGNAL WORD

Type and source of the hazard

- Consequences of non-compliance with the notes
- Measures to avoid that risk

Depending on the danger level, different signal words are used:

| Signal word | Danger level | Consequences of non-compliance |
|--------------------|------------------------------|---------------------------------------|
| CAUTION | Possibly dangerous situation | Minor bodily injury |
| ATTENTION | Possibly dangerous situation | Damage to material property |

1.3.2 General symbols

| Symbol | Meaning |
|---------------|--|
| ■ | A small black square indicates the work you have to perform. |
| – | The dash denotes lists. |

2. Safety notes

Various dangers may occur if the hand lever grease gun is improperly handled during installation, commissioning and daily operation.



WARNING

Risk of injury and damage to material property because of improper handling!

- Hold the manual at the disposal of the operating staff at the usage site of the unit.
 - Country-specific safety measures and accident prevention regulations must be observed.
-

2.1 Authorized personnel

Only qualified and authorized persons are allowed to operate and to work on the hand lever grease gun.

Persons are qualified if they are, due to their training, experience, instruction and knowledge of the relevant standards, able to assess assigned tasks and to identify potentially hazardous situations.

All persons charged with installation, operation, maintenance and repair work, must have read and understood this operation instructions.

2.2 Intended conditions of use

The grease gun is designed exclusively for the delivery of grease lubricants.

Any use beyond these parameters can lead to serious risks and is regarded as use that is contrary to the intended purpose.

The operator is responsible for damages resulting from use other than the intended use.

3. Design and functional description

The grease gun is equipped with a spring-loaded sealing sleeve to support the grease delivery.

The grease gun can be fitted with a very wide range of accessories.

The grease gun is available in the following models:

- Industrial grease gun Elite K9
- Industrial grease gun 1 and 2
- Standard grease gun

4. Area of application

The grease gun is suitable for supplying lubricant greases up to viscosity class NLGI 2 under pressure.

The grease gun can be filled using a commercially available grease cartridge which complies with DIN 1284, with unpacked grease, or using a grease gun filling unit.

5. Technical data

| Grease gun | Industrial grease gun ELITE K9 | Industrial grease gun 1 and 2 | Standard grease gun |
|--------------------------------------|--|--|--|
| Diameter of grease piston: | 9 mm | 9 mm | 8 mm |
| Supply volume/stroke: | 1,4 cm ³ | 1,4 cm ³ | 1,2 cm ³ |
| Supply pressure: | up to 400 bar | up to 400 bar | up to 400 bar |
| Grease gun discharge connection: | M 10 x 1 or G 1/8" | M 10 x 1 or G 1/8" | M 10 x 1 or G 1/8" |
| Bursting pressure (system): | 850 bar | 850 bar | 850 bar |
| Bursting pressure (grease gun head): | 1200 bar | 1200 bar | 1200 bar |
| Capacity: | 500 cm ³ | 500 cm ³ | 500 cm ³ |
| Filling options: | 400-g grease cartridge (DIN 1284), loose grease, grease gun filling device | 400-g grease cartridge (DIN 1284), loose grease, grease gun filling device | 400-g grease cartridge (DIN 1284), loose grease, grease gun filling device |

Tab. 5-1: Technical data

6. Hazards when handling the grease gun



CAUTION

Excess pressure can result in the bursting of the grease gun head and of accessories!

- Do not use force when actuating the hand lever.
- Do not use an extension or other auxiliary.
- Do not exceed the operating pressures specified in chapter 5.
- Use only original accessories compliant with DIN 1283.

Excess pressure at the greasing point can damage the grease nipple, bearings and even the machine!

- Comply with the machine manufacturer's maintenance and service instructions.



CAUTION

Defective accessories can lead to personal injury and material damage!

- High pressure hoses must not be kinked, twisted or stretched.
- During their period of use, accessories must be checked for wear, cracks, and other damage.
- Defective accessories should be replaced immediately.
- The period of use for connecting hoses is a maximum of 6 years after the date of manufacture (see hose labelling).

7. Assembly

The grease gun is supplied fully assembled.

Depending on the model, accessories can or must be fitted.



NOTE

- When fitting accessories, ensure cleanliness and an exact connection of the accessories with the grease gun head.
- Use suitable sealants and adhesives (e.g. Teflon tape).
- When changing the spout or high pressure hose, the valve in the grease gun head must not be unscrewed.

8. First use and recommissioning

Check the grease gun and fitted accessories for completeness.

8.1 Filling the grease gun

There are various filling options for the grease gun.

- Filling with grease gun filling device
- Filling with grease cartridge according to DIN 1284
- Filling with loose grease using a spatula

8.1.1 Filling with grease gun filling device



CAUTION

- Do not open the grease gun when it is under pressure!
- Every time that the grease gun head and cylinder are to be separated, the push rod must be fully retracted and automatically locked by means of the safety catch.

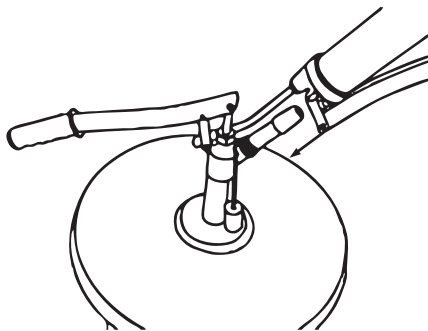

Place the grease gun onto the filling valve of the grease gun filling unit, and hold it in place with light counter pressure.

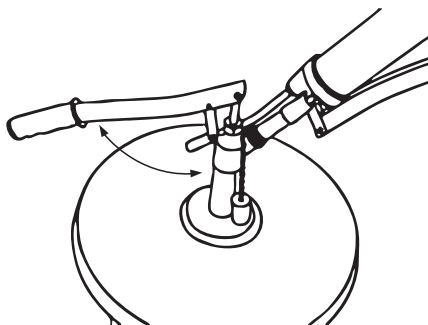

Fill the grease gun by activating the filling device. Filling may cause the push rod to be pushed out of the grease gun cylinder.

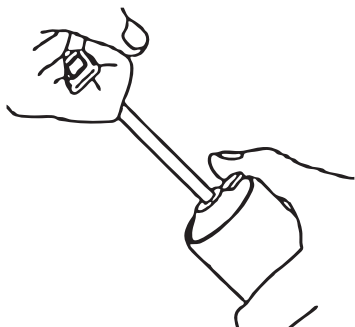

While pulling on the push rod, activate the safety catch and push the push rod back into the cylinder.

8.1.2 Filling with grease cartridge according to DIN 1284



CAUTION

- Do not open the grease gun when it is under pressure!
- Every time that the grease gun head and cylinder are to be separated, the push rod must be fully retracted and automatically locked by means of the safety catch.

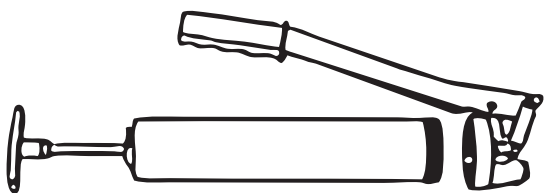

Pull back the push rod and unscrew the grease gun head.

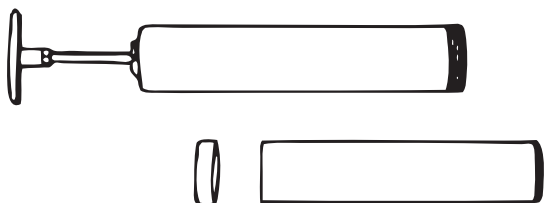

Remove the sealing cap from the full cartridge, and guide this into the grease gun cylinder..

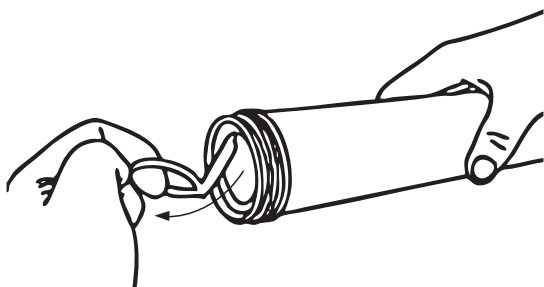

Only then tear off the cartridge's „pull-off“ closure and screw on the grease gun head.

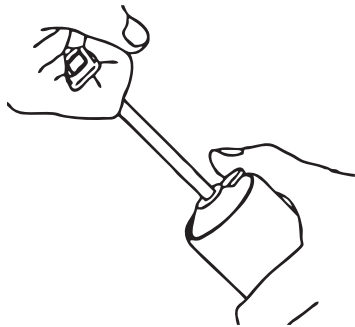

Pull on the push rod, actuate the safety catch, and push the push rod back into the cylinder.

8.2 Making the grease gun ready for operation



NOTE

- Check that the grease gun head and cylinder are tightly screwed together.

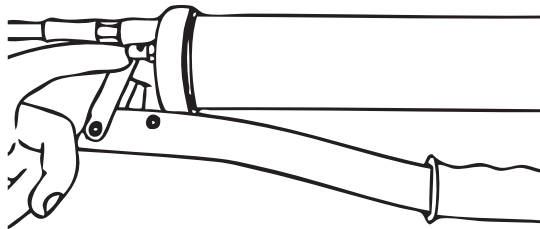

Remove air from the grease-containing section via the combined filling / air removal nipple on the grease gun head by loosening the gun head and cylinder (half a turn maximum) or by repeatedly actuating the hand lever.

The grease gun is now ready for use.

9. Operation



CAUTION

Excess pressure can result in the bursting of the grease gun head and of equipment!

- When using the grease gun, use suitable equipment such as protective gloves and eye protection.

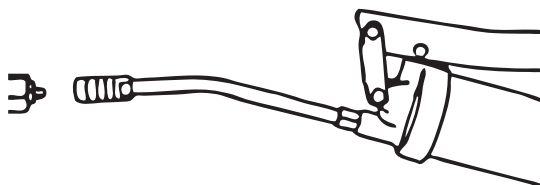

Position the grease gun with the hydraulic mouthpiece onto the grease nipple.

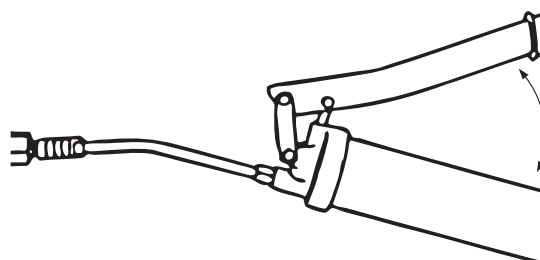

Actuate the hand lever to carry out the greasing process.

10. Care/Maintenance

In principle, the hand lever grease gun needs little care and maintenance.

Because of operator responsibility, the following parts must be checked regularly in order to avoid environmental, material, or personal damage:

- Grease gun head
- Screwed connections
- Accessories (hoses, mouthpieces, etc).

11. Replacement parts/accessories

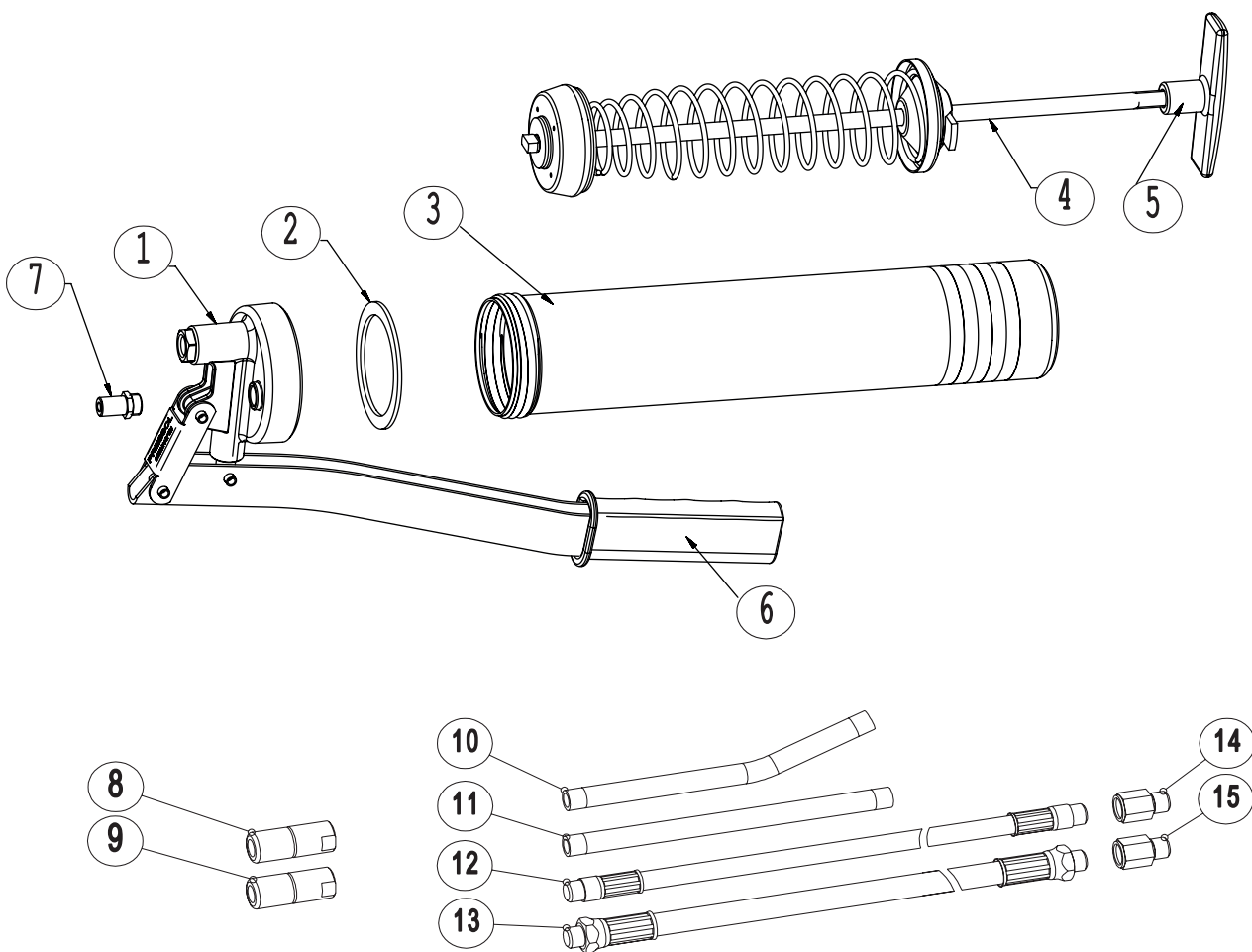

Fig. 11-1: Replacement parts and accessories

Replacement parts

| Pos. | Description | | ELITE K9 | Industrial 1 | Industrial 2 | Standard |
|------|-------------------------------|----------|----------|--------------|--------------|----------|
| 1 | Grease gun head with lever | M 10 x 1 | 00 535 | 87 700 | 87 700 | 00 581 |
| | | G 1/8" | – | 87 701 | – | 00 581 |
| 2 | Seal | | 00 442 | 00 442 | 00 442 | 00 442 |
| 3 | Cylinder, 500 cm ³ | | 00 677 | 00 361 | 87 240 | 00 361 |
| 4 | Push rod | | 00 538 | 00 443 | 01 991 | 00 443 |
| 5 | Push rod handle | | 00 219 | – | 02 740 | – |
| 6 | Handle | | 87 084 | 87 084 | 87 084 | 87 084 |
| 7 | Filling nipple | | 12 670 | 12 670 | 12 670 | 12 670 |

Accessories according to DIN 1283

(extract from the PRESSOL range of accessories)

| Pos. | Description | | M 10 x 1 | G 1/8" |
|------|--|--------|----------|--------|
| 8 | Hydraulic coupler | | 12 631 | 12 731 |
| 9 | Precision coupler | | 12 643 | 12 743 |
| 10 | Spout-angled | | 12 635 | 12 735 |
| 11 | Spout-straight | | 12 435 | 12 475 |
| 12 | High pressure hose, 8 x 300 mm | | 12 656 | 12 756 |
| 13 | High pressure hose, 11 x 300 mm | | 12 655 | 12 755 |
| 14 | Retention adapter, G 1/8" female; M 10 x 1 male | 12 016 | | |
| 15 | Retention adapter, G 1/8" male; M 10 x 1 female | 12 086 | | |

11. Disposal

The operating company is responsible for the proper disposal of the hand lever grease gun.

Dispose of the different materials in accordance with all industry-specific, local, regional and federal regulations.

Only qualified personnel is authorized to disassemble and dispose of the hand lever grease gun.

12. Repair/Service

The hand lever grease gun has been developed and produced according to the highest quality standards.

Should a problem develop, despite of all quality controls, please contact our customer service:

PRESSOL Schmiergeräte GmbH

Tel +49 9462 17-216

Fax +49 9462 1063

service@pressol.com

Pressol Schmiergeräte GmbH

Parkstraße 7

93167 Falkenstein | Germany

Tel. +49 9462 17-0

Fax +49 9462 17-208

info@pressol.com

www.pressol.com

